

# Screen-Systems

Healthcare | 2025



**ropimex**<sup>®</sup>  
since 1976



Please visit  
our  
virtual showroom



Scan



## ropimex® HyGentle: Product design and material combination for maximum hygiene

### Product design:

Hygiene starts with the design. Corners, angles or geometries that are ill-suited for cleaning and disinfection are avoided to the greatest possible extent.

### Material composition:

Cleanability and disinfectability are prioritized in the selection of the materials required for manufacturing the product. This is aimed at achieving an optimum where soiling and microbiological pollution are concerned. Porous, absorbent surfaces must be avoided.

### Cleaning and disinfection:

We test and document the materials of our products in terms of their natural microbial contamination, just as we document their cleanability and disinfectability with commercially available detergents and disinfectants.

### CE - Medical device

ropimex®-products meet the requirements of the regulatory specifications for medical devices.



Telescopic screens,  
Telescopic arms RTS/RTI..... 4 - 13

Wall brackets /  
Brackets for equipment rails  
WH..., GSH... .....14 - 15

Mobile screens FG95 .....16 - 17

Vario rail system RVS .....18 - 21

Curtains  
RTX, VHC, CQ, Z .....22 - 25

ropiCARE Folding curtain.....26 - 27

Folding screens RFW ..... 28 - 35

Butterfly Folding wall RBF ..... 36 - 39

Butterfly Paravent RBP .....40 - 41

Paravents RLP..... 42 - 45

Telescopic cubicle RKLE...,  
Shower splash guard RD... ..... 46 - 47

About us / Certificates .....48 - 51

Certified according to  
DIN EN ISO 9001:2015 and  
DIN EN ISO 14001:2015



# Telescopic arms

You can't trip over things that hang on the wall. Which is why we created ropimex® telescopic screens, the screen that's only there when it's needed. After use, simply push the screen together and turn it towards the wall. Your room is back to looking its familiar self.

To a max. 210 cm  
Model RTS:  
swing-out



To a max. 220 cm  
Model RTI:  
Fold-down and  
swing-out



From 220 cm  
Model RTH:  
with hooks and  
ceiling mounts



CE

# Telescopic arms

Optimized in handling, cleaning and disinfection



Smooth telescopic tubes and plastics for one hygiene-friendly surface.

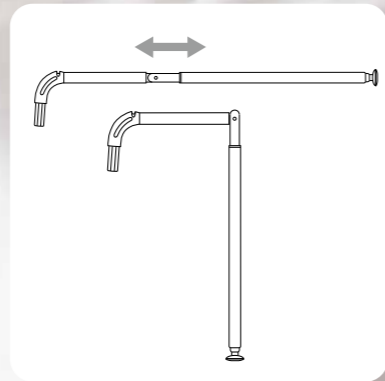

Model RTI: Bending mechanism seamlessly integrated.



If the curtain rings are loaded they release themselves from the eyelets of the curtains and therefore avoid injuries and damage to the system.

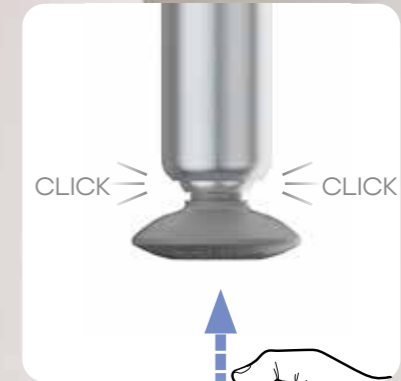

Tail with locking - fixed telescope at rest



# Telescopic arms

Model **RTS** - swing-out







Telescopic screen Model RTS - swing-out



ropimex® - telescopic screens are made of anodised aluminium, high-quality, glass-fibre reinforced plastics. Easy to clean and to disinfect.



Model      Telescopic screen extension      Weight

|         |  |        |  |
|---------|--|--------|--|
| RTS 1.2 | 55 cm → 120 cm  | 0,5 kg | Curtain rings included in the scope of delivery<br> |
| RTS 1.5 | 65 cm → 150 cm  | 0,6 kg |  |
| RTS 2.1 | 85 cm → 210 cm  | 0,7 kg |  |



If they are loaded they release themselves from the eyelets of the curtains and therefore avoid injuries and damage to the system.

Wall and rail brackets  
see page 14



Recommended curtains see from page 22

RTX ropitex

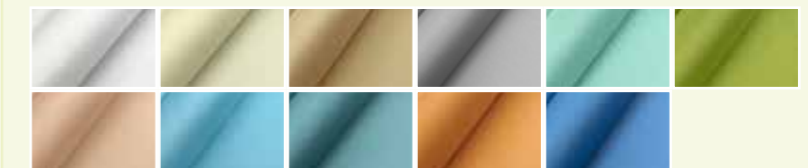

CQ Cleanique

VHC staph CHEK

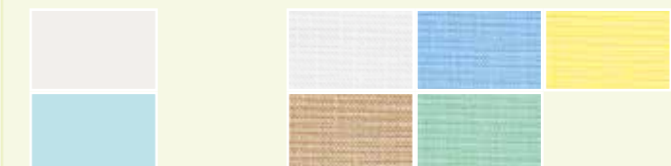

# Telescopic arms

Model RTI - Fold-down and swing-out



Telescopic screen Model RTI - Fold-down and swing-out



ropimex® - telescopic screens are made of anodised aluminium, high-quality, glass-fibre reinforced plastics. Easy to clean and to disinfect.



Model Telescopic screen extension Weight

| Model   | Telescopic screen extension   | Weight |
|---------|---|--------|
| RTI 1.3 | 70 cm → 130 cm   | 0,6 kg |
| RTI 1.6 | 80 cm → 160 cm   | 0,7 kg |
| RTI 2.2 | 100 cm → 220 cm  | 0,8 kg |

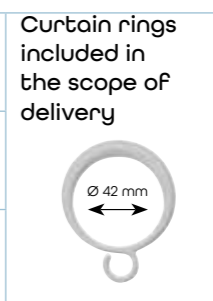

If they are loaded they release themselves from the eyelets of the curtains and therefore avoid injuries and damage to the system.

## Wall and rail brackets see page 14



## Recommended curtains see from page 22

RTX ropitex



CQ Cleanique

VHC staph CHEK

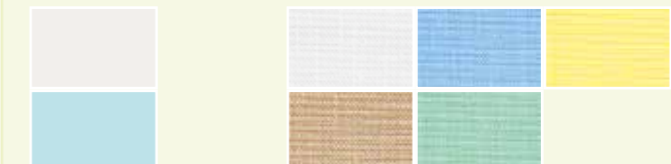

# Telescopic arms

## Model RTH - fold-down and swing-out with end support

Used in combination with a height-adjustable ceiling mount RST or with an end support (GL), with the longest telescopic arm RTH 350 you can achieve a screen length of 350 cm.



## Telescopic screen Model RTH - fold-down and swing-out with end support

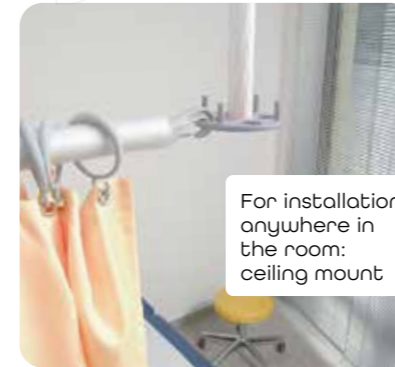
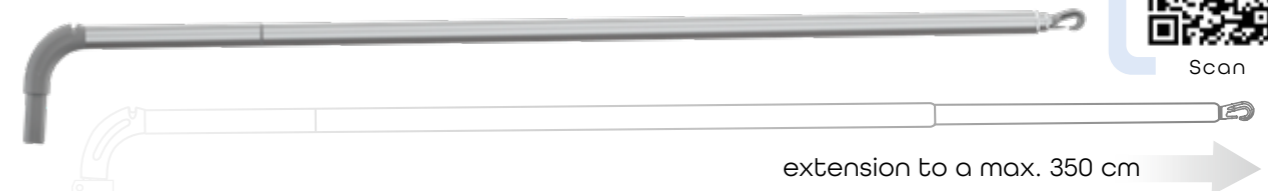





For installation anywhere in the room: ceiling mount



For wall-to-wall installation: end support (GL)

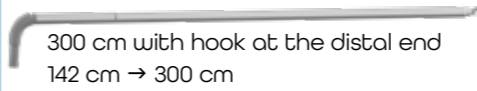

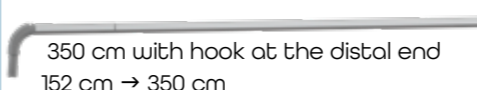
ropimex® - telescopic screens are made of anodised aluminium, high-quality, glass-fibre reinforced plastics. Easy to clean and to disinfect.

| Model   | Telescopic screen extension   | Weight | Included in the scope of delivery   |
|---------|---|--------|---|
| RTH 300 |  300 cm with hook at the distal end<br>142 cm → 300 cm | 1,0 kg | <b>Wall bracket</b> WH 95    |
| RTH 350 |  350 cm with hook at the distal end<br>152 cm → 350 cm | 1,1 kg | <b>Ring VR</b> <br><b>End support GL</b>  |

## Model RST - adjustable ceiling mounts

| Model   | Extension   | Room height From - to |
|---------|-------------|-----------------------|
| RST 4   | 45 -75 cm   | 245 - 275 cm          |
| RST 8   | 75 -135 cm  | 275 - 335 cm          |
| RST 10* | 110 -200 cm | 335 - 400 cm          |

\*not illustrated

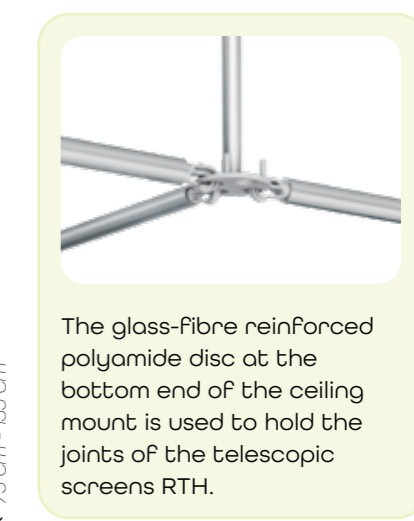

The glass-fibre reinforced polyamide disc at the bottom end of the ceiling mount is used to hold the joints of the telescopic screens RTH.

# Brackets for telescopic screens

Model **WH** - Wall brackets  
 Model **GSH** - Brackets for equipment rails



## WH: Wall brackets for telescopic screens



| Model    |  | Dimensions                   |
|----------|--|------------------------------|
| WH 95    | Wall bracket for all telescopic screens, die-cast aluminium, concealed screws, adjustable to compensate for unevenness of the wall, colour coated, colours: white (RAL 9010), signal grey (RAL 7004) | Height 10 cm<br>Width 6 cm   |
| WH 95 PL | For walls with low strength, e.g. plasterboard. Wall bracket for all telescopic screens. White or grey, concealed screws, with backplate 20/15 cm  | Height 15 cm<br>Width 20 cm  |
| WH       | Wall bracket for all telescopic screen   | Height 16,5 cm<br>Width 6 cm |
| WH/LA    | Wall bracket for bridging service ducts up to 15 cm  |                              |
| WH/F     | Wall bracket with knurled thumb screw  |                              |

## GSH: Brackets for equipment rails

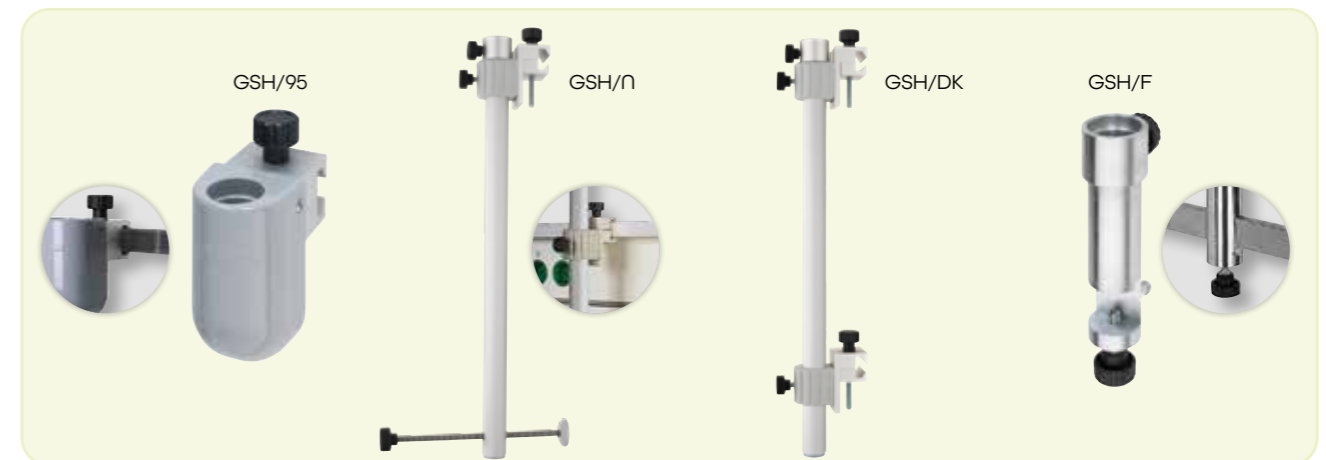

| Model  |  | Dimensions                   |
|--------|--|------------------------------|
| GSH/95 | Bracket for equipment rails, adjustable tilt                           | Height 10 cm<br>Width 6 cm   |
| GSH/N  | Bracket for equipment rails, wall-supported, height-adjustable         | Height 55 cm<br>Width 5 cm   |
| GSH/DK | Bracket with "double clamp" for equipment rails, height-adjustable     | Height 55 cm<br>Width 5 cm   |
| GSH/F  | Bracket for equipment rail 25/10 mm, fixing by means of clamping screw | Height 13,5 cm<br>Width 4 cm |

Mobile screens Model FG95



FG95 trolley

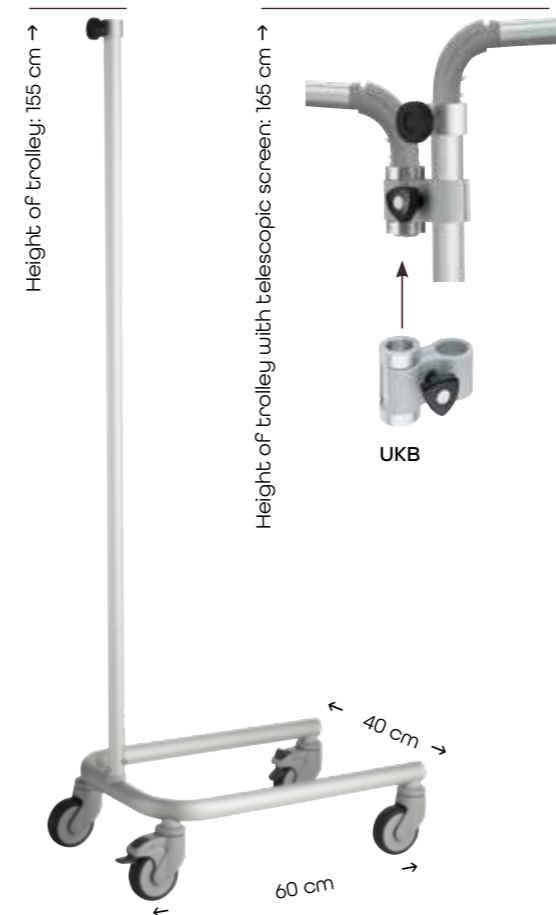

Model

|      |   |
|------|---|
| FG95 | Trolley, 155x60x40 cm (H/D/W), 4 castors ø 100 mm, 2 of which are lockable. Aluminium anodised, glass-fibre reinforced polyamide, corrosion-resistant, disinfectable.<br><br>The FG 95 trolley can be fitted with all telescopes of the 'RTI' model series. |
| LA   | Electrically conductive castors available for an extra charge.  |
| UKB  | Universal clamp for holding a second telescopic screen - RTI 1.3 or RTI 1.6.  |

Telescopic screen Model RTI



We recommend the following fitout

With one telescopic screen

|         |  |
|---------|--|
| RTI 2.2 | Telescopic screen, Fold-down, extension 220 cm |
|---------|--|

With two telescopic screens and UKB clamp

|         |   |
|---------|---|
| RTI 2.2 | Telescopic screen, Fold-down, extension 220 cm (not suitable for the UKB clamp) |
| RTI 1.6 | Telescopic screen, Fold-down, extension 160 cm                                  |
| RTI 1.3 | Telescopic screen, Fold-down, extension 130 cm                                  |

Recommended curtains see From page 22

RTX ropitex



CQ Cleanique



VHC staph CHEK

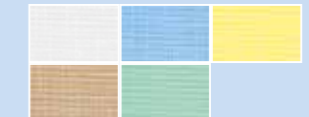

# Vario rail system

Model **RVS**

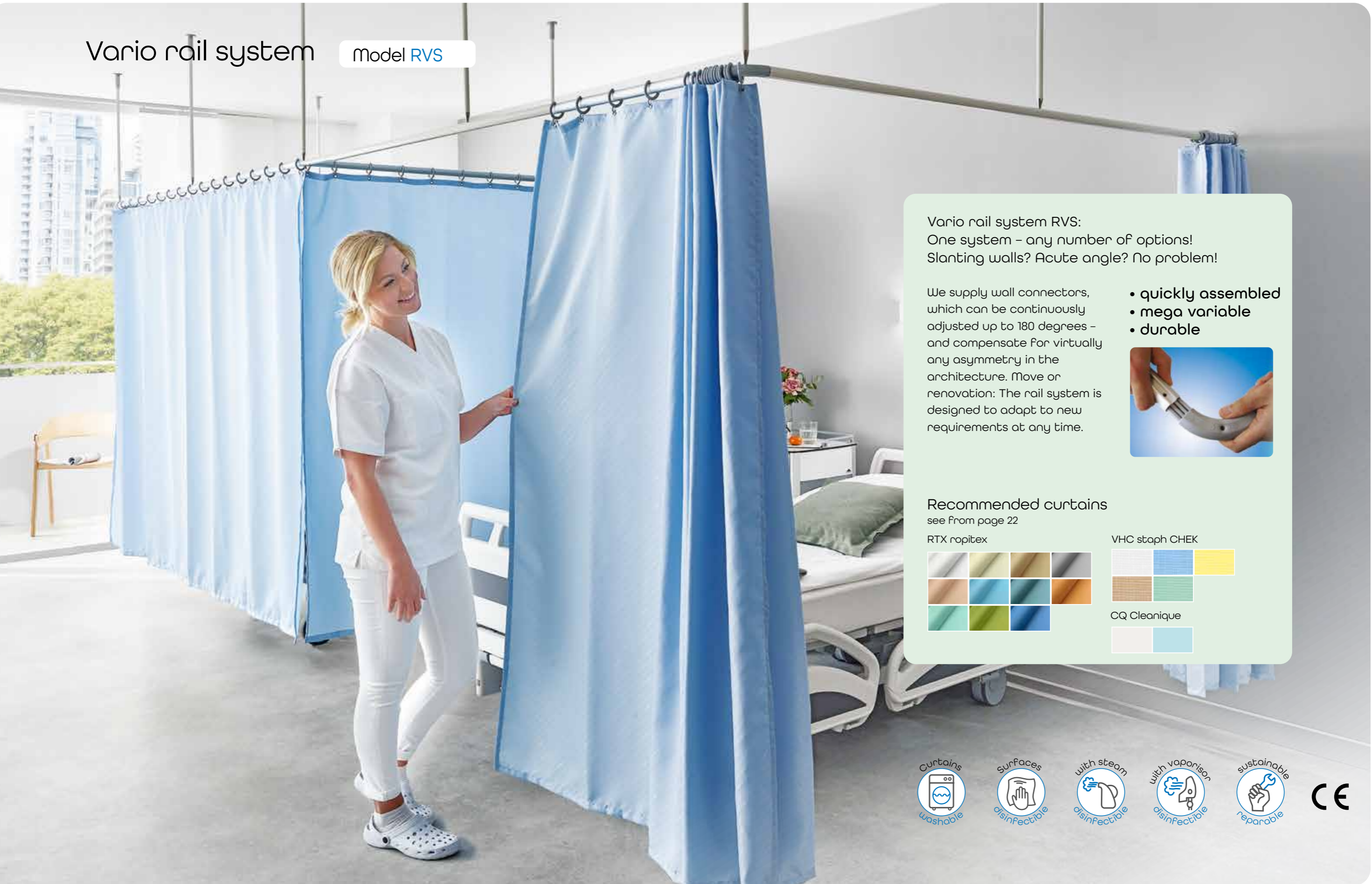

Vario rail system RVS:  
One system - any number of options!  
Slanting walls? Acute angle? No problem!

We supply wall connectors, which can be continuously adjusted up to 180 degrees - and compensate for virtually any asymmetry in the architecture. Move or renovation: The rail system is designed to adapt to new requirements at any time.

- quickly assembled
- mega variable
- durable



Recommended curtains  
see From page 22

RTX ropitex

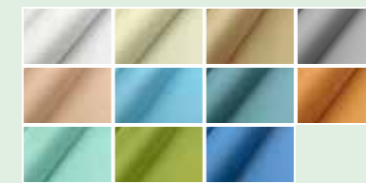

VHC staph CHEK



CQ Cleanique



# Vario rail system Model RVS



Easy ordering: A simple sketch suffices!

Simply prepare a hand-drawn, dimensioned sketch of the required room layout, enter the widths and lengths as well as the room height and the required headroom.

**We will put together the complete system for you.**

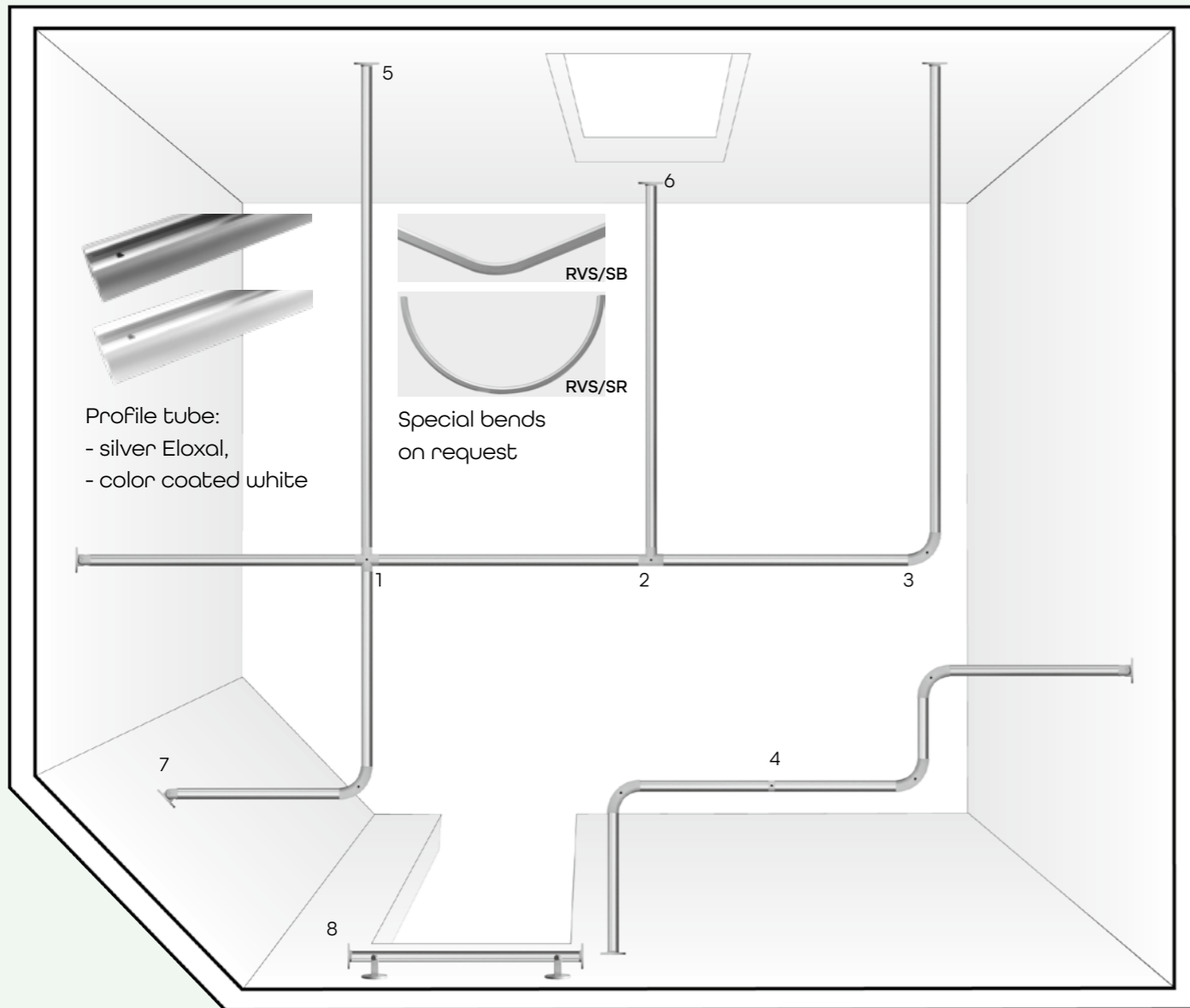

**Curtain ring RVS/VR** made of unbreakable polyamide: Releases itself from the curtain eyelet if overloaded (approx. 2 kg).



**Ringstopper:** For fixation of a curtain ring at the beginning or the end of the rail.

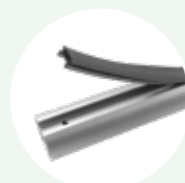

**Silicone cover profile RVS/AP**

With the RVS connectors, you can create cabs as you wish

1

Cross-connector  
(RVS/KV)

2

T-connector  
(RVS/TV)

3

Corner solutions  
RVS/BV  
(radius 60 mm)

4

**Change later:**  
simply disconnect the profile tube and install the connector of your choice, e.g. linear connector RVS/LV

## RVS-Wall connections - for every requirement

5

**Free-standing end:**  
End cap RVS/EK stops the curtain.

6

**Straight at the wall:**  
Wall connector RVS/WA

7

**Sloped walls, acute angles:** the Vario wall connector RVS/WAV compensates for and levels out asymmetries up to 180° and length differences up to +/- 5 mm.

## Flexible to the ceiling - RVS ceiling connectors

**Mounted directly under the ceiling:**  
with ceiling bracket RVS/DH (distance from top of ceiling to bottom of rail approx. 6 cm).

**Easy above the lintel:** e.g. at windows or doors using the wall connector RVS/WAS

**Suspended at headroom height:**  
with the adjustable ceiling mount (+/- 20 mm) RVS/DS

**For free-standing end RVS rails:**  
adjustable double ceiling mount (+/- 2cm) RVS/DDS

Cover cap for suspended ceilings

RVS/DDSPL  
Reinforcing disc for ceiling support for e.g. plaster-board ceilings

**Anchoring on profile rail:**  
possible along the whole length by means of square nut; for adjustable ceiling mount RVS/DS or with ceiling bracket RVS/DH. Max. spacing: 2 m.

**Anchoring via all connectors:**  
Standard threaded hole for screwing in the adjustable ceiling mount RVS/DS or the ceiling bracket RVS/DH ensures firm support.

**Spacer:**  
RVS/AH for Corner- and T-Solutions.

# Curtains



RTX: ropitex BIOACTIVE the new ropimex® curtain for sanitary blocks made of 100 % bioactive polyester fibre



- Width: 210 cm
- Weight: 140 g/m<sup>2</sup>



- Care instructions
- 

### Standard dimensions

|         | Width | Height in cm |
|---------|-------|--------------|
| RTX 110 | 110   | 175          |
| RTX 121 | 140   | 120          |
| RTX 122 | 140   | 140          |
| RTX 123 | 140   | 175          |
| RTX 151 | 170   | 120          |
| RTX 152 | 170   | 140          |
| RTX 153 | 170   | 175          |
| RTX 200 | 200   | 175          |
| RTX 211 | 230   | 120          |
| RTX 212 | 230   | 140          |
| RTX 213 | 230   | 175          |
| RTX 215 | 250   | 175          |
| RTX 217 | 270   | 175          |
| RTX 300 | 300   | 175          |
| RTX 330 | 330   | 175          |
| RTX 360 | 360   | 175          |
| RTX 390 | 390   | 175          |
| RTX 420 | 420   | 175          |
| RTX 460 | 460   | 175          |
| RTX 500 | 500   | 175          |

Special dimensions on request.

Available in 11 colours



Flame retardant curtains can save lives!



VH/C: ropimex® curtains made of staph CHEK, the fabric for sanitary blocks, showers and bathrooms



- Width: 180 cm
- Weight: 330 g/m<sup>2</sup>



### Standard dimensions

|          | Width | Height in cm |
|----------|-------|--------------|
| VH/C 121 | 140   | 120          |
| VH/C 122 | 140   | 140          |
| VH/C 151 | 170   | 120          |
| VH/C 152 | 170   | 140          |
| VH/C 211 | 220   | 120          |
| VH/C 212 | 220   | 140          |

Special dimensions on request.

- Care instructions
- 

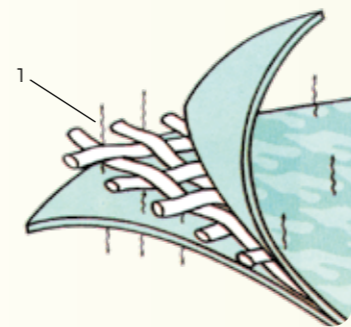

1. Sustainably integrated: active antibacterial components

Available in 5 colours





## Cleanique®

CQ: ropimex®- seamless Hygienic-curtain made of thermoplastic polyether polyurethane for sanitary blocks and wet room

- Width: 190 cm
- Weight: 270 g/m<sup>2</sup>



Standard dimensions

|        | Width | Height in cm |
|--------|-------|--------------|
| CQ108  | 100   | 80           |
| CQ128  | 120   | 80           |
| CQ121  | 140   | 120          |
| CQ122  | 140   | 140          |
| CQ123  | 140   | 170          |
| CQ151  | 170   | 120          |
| CQ152  | 170   | 140          |
| CQ153  | 170   | 140          |
| CQ211  | 220   | 120          |
| CQ212  | 220   | 140          |
| CQ213  | 220   | 170          |
| CQ1220 | 120   | 190          |
| CQ1420 | 140   | 190          |
| CQ1620 | 160   | 190          |
| CQ1820 | 180   | 190          |
| CQ2020 | 200   | 190          |
| CQ2220 | 220   | 190          |
| CQ2420 | 240   | 190          |
| CQ2720 | 270   | 190          |
| CQ3020 | 300   | 190          |
| CQ3320 | 330   | 190          |

- Care instructions
- and disinfectable on the surface



Available in 2 colours

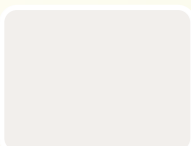

velvet-white



sky blue

Special dimensions on request.

# ZEROTEX



## ZEROTEX

ropimex® Zerøtex - non-woven made of 100 % polypropylene (PP). Saves time and money

- Width: ca. 210 cm
- Weight: 70 g/m<sup>2</sup>



Suitable for ropimex RTS telescopes and RTI as well as the RVS rail system



Standard dimensions

| Width x Height in cm |           |  |
|----------------------|-----------|--|
| suitable for         |           |  |
| Z1516                | 150 x 160 |  |
| Z1517                | 150 x 175 |  |
| Z1816                | 180 x 160 |  |
| Z1817                | 180 x 175 |  |
| Z2116                | 210 x 160 |  |
| Z2117                | 210 x 175 |  |

Minimum order quantity 10 pieces / per colour and size

Available in 5 colours



blue



yellow



light grey

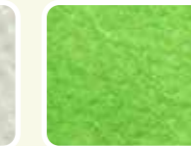

apple green



creme

# Folding Curtain ropicare

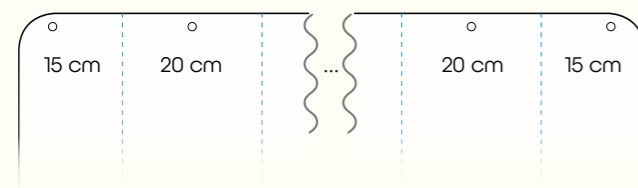

Slat width: 20 cm,  
Start and end slat: 15 cm



Only in connection with ropimex® Vario RVS rail system, color coated white (see page 18 - 21)



ROC : ropimex®- Folding curtain made of PVC/polyester fabric. Easy care - no washing required



- Width: 180 cm
- Weight: 570 g/m<sup>2</sup>



- Fire retardant
- Impervious to liquids
- Durable
- Recyclable
- Care instructions: disinfectable on the surface

### Standard dimensions

|         | Width | Height in cm |
|---------|-------|--------------|
| ROC 110 | 110   | 175          |
| ROC 130 | 130   | 175          |
| ROC 150 | 150   | 175          |
| ROC 170 | 170   | 175          |
| ROC 190 | 190   | 175          |
| ROC 210 | 210   | 175          |
| ROC 230 | 230   | 175          |
| ROC 250 | 250   | 175          |
| ROC 270 | 270   | 175          |
| ROC 290 | 290   | 175          |
| ROC 310 | 310   | 175          |

Special dimensions on request.



Optionally available with a transparent area covering the entire width of the curtain.

Available in 8 colours

- white
- champagne
- light grey
- orange
- yellow
- carambola
- light blue
- turquoise

- Curtain rings ROC/VR**  
Curtain rings with swivelling hook (specially for ropicare and Vario Rail System), not included in the delivery
- Ringstopper RVS/RS**  
Ringstopper to block the curtain at the end or beginning

# Folding screens

RFW - wall-mounted



Infill panels:  
non-see-through but  
translucent

Non-see-through 360°  
hinges

**10** YEARS  
warranty  
on hinge  
system

The robust and impact-resistant Folding screen is positioned in seconds and parked back against the wall after use.

Non-see-through but translucent leaf infill material with high-quality aluminium profile creates a pleasant, light atmosphere.

Modern leaf designs, available in different colours, give the folding screen an individual touch.



CE



## Folding wall RFW wall-mounted



Folding screen for wall-mounting RFW

|               |   |
|---------------|---|
| Leaf width    | 30 cm   |
| Heights       | 145 / 165 / 185 cm  |
| Weight        | 3,00 / 3,50 / 4,00 kg / leaf  |
| Frame         | Frame and hinged profiles: extruded aluminium (Al Mg Si 05), anodised surface, connecting screws: V2A stainless steel             |
| Plastic parts | PA 6 GF 15, polyamide with 15% glass fibres   |
| Infill panels | Polycarbonate, 2 mm, white, translucent, Flame resistant, construction material class B1, DIN 4102-01, extremely impact resistant |
| Pflege        | commercially available cleaning product and disinfectant  |

| Screen  | open width |  |
|---------|------------|--|
| 3-leaf  | 90 cm      |  |
| 4-leaf  | 120 cm     |  |
| 5-leaf  | 150 cm     |  |
| 6-leaf  | 180 cm     |  |
| 7-leaf  | 210 cm     |  |
| 8-leaf  | 240 cm     |  |
| 9-leaf  | 270 cm     |  |
| 10-leaf | 300 cm     |  |

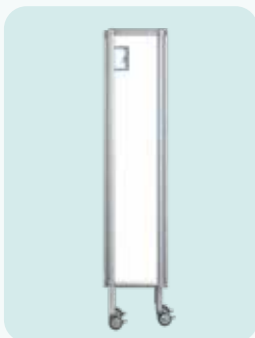

Non-see-through 360° hinges.  
The RTC unit (ropimex®-Turn&Connect) enables 360° leaf rotation.

29 colours  
21 designs  
see pages 34-35



## Folding screen RFW Accessories



Spacer set  
For wall fixing  
RFW-WA

Spacer for wall fixing, standard spacing 100 mm, special length to customer-specified dimensions possible up to 400 mm



Clamp set  
RFW-KLS

Clamp set for fixing to double-track standard rail

## Folding screen RFW column-mounted



### Stainless steel column for folding screen

Ideal wherever wall-mounting is not possible. Stainless steel column with dimensions 5 x 5 cm.

Available in 3 heights.

|                |                               |
|----------------|-------------------------------|
| RFW-ES4        | Height 145 cm, weight 5,00 kg |
| RFW-ES6        | Height 165 cm, weight 5,50 kg |
| RFW-ES8        | Height 185 cm, weight 6,20 kg |
| Folding screen | Description see page 30       |



Stainless steel column with possibility to fix up to 4 Folding walls



# Folding screens RFW - with trolley



Infill panels:  
non-see-through but translucent

Non-see-through 360° hinges

**10** YEARS  
warranty on hinge system



**Folding screen RFW with trolley:** Position, fold open, fold together after use and roll away – care of the easy-clean surfaces made of aluminium and scratch-resistant polycarbonate is just as easy as the handling.



### Trolley for Folding screen

The mobile version with max. 10 leaves enables mobile use. Please note: mobile folding screens are available in heights 145 and 165 cm only

|                |   |
|----------------|---|
| RFW-FG4        | Height 145 cm, weight 14 kg                   |
| RFW-FG6        | Height 165 cm, weight 15 kg                   |
| Trolley base   | 52 x 59 cm                                    |
| Folding screen | For description and screen length see page 30 |

**Note:** Mounted on a trolley, the folding screen is only mobile. It is therefore not possible to convert it to a wall-mounted screen or to fix it to an equipment rail or column.

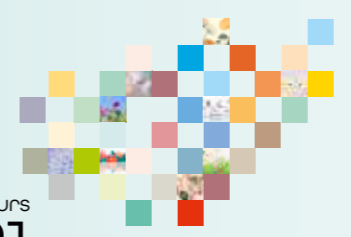















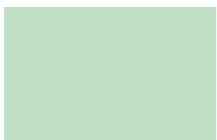

29 colours  
21 designs  
see pages 34-35

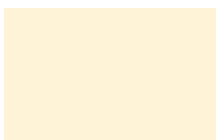

For easy handling - ingenious details such as lockable castors and lifting mechanism

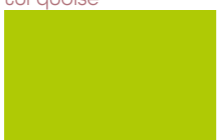
# Folding wall RFW 29 Colours

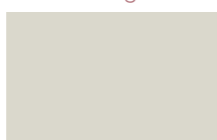
Colours and designs on option

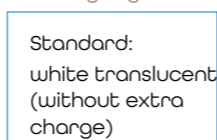
|   |   |   |  |   |
|---|---|---|--|---|
|    |    |    |    |    |
| 01 Golden yellow  | 02 Bath tuquoise  | 03 Clove red  | 04 Lightblue   | 05 Copper brown   |
|    |    |    |    |    |
| 06 Vespa yellow   | 07 Opal turquoise   | 08 Red grey   | 09 Paris blue  | 10 Melon red  |
|    |    |    |    |    |
| 11 Apricot creme  | 12 Clown green  | 13 Tulle violet   | 14 Madonna blue  | 15 Apricot orange   |
|    |    |    |    |    |
| 16 Milk star white  | 17 Pale mountain lake turquoise   | 18 Rosewood apricot   | 19 Blue Grey   | 20 Mohair mauve   |
|  |  |  |  |  |
| 21 Nile green   | 22 Marker green   | 23 Sahara light red   | 24 Bermuda blue  | 25 Soft greige  |
|  |  |  |  |  |
| 26 Foggy grey   | 27 Pale pistachio   | 28 Pepper white   | 29 Vintage white   | 30 Standard white translucent   |

Standard:  
white translucent  
(without extra  
charge)

Customize your folding wall online:





<https://ropimex.com/en/configurator/>



Colours based on RAL D2. Printed colours may deviate for technical reasons.

# Folding wall RFW 21 designs

|           |   |   |   |
|-----------|---|---|---|
| structure |    |    |    |
|           | Brightwood  | Darkwood  | Abstract  |
| Floral    |    |    |    |
|           | Ginkgo  | Yellowpalm  | Dandelion   |
| landscape |    |    |    |
|           | Wildplants  | Pivoine   | Papillion   |
| kids      |  |  |  |
|           | Meadow  | Lavender  | Leaves  |
| kids      |  |  |  |
|           | Relaxbeach  | Heron   | Town  |
| kids      |  |  |  |
|           | Flamingo  | Bananaplants  | Dreambeach  |
| kids      |  |  |  |
|           | Dino  | Space   | Submarine   |

# Butterfly Folding wall Model RBF

Infill panels:  
non-see-through but  
translucent

Non-see-through 360°  
hinges

**10**  
YEARS  
warranty  
on hinge  
system



available in 2 dimensions

RBF

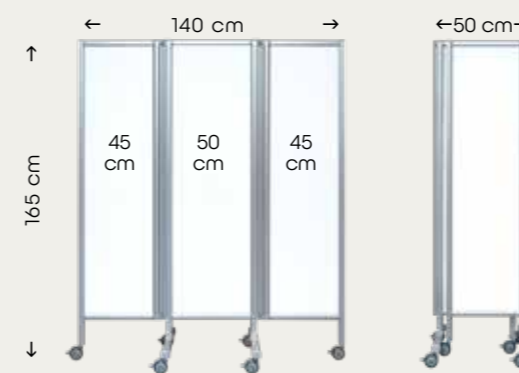

weight: 15,20 kg

RBF200

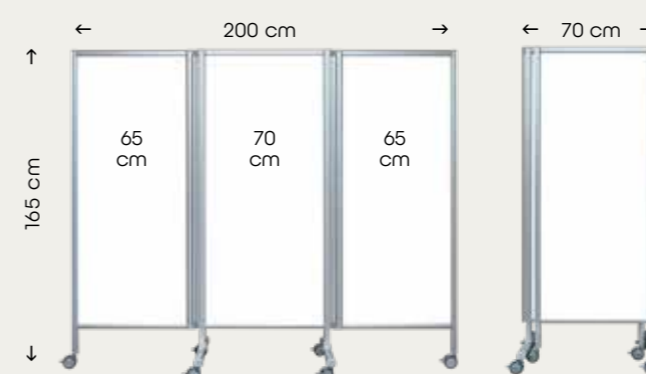

weight: 18,00 kg

ropimex® Butterfly Folding wall RBF

3-leaf made in polycarbonate, with middle leaf centred on double T-leg and 360° rotatable leaves on either side, Fold-away.

|          |  |
|----------|--|
| Material | Frame and hinges: extruded aluminium (Al Mg Si 05), anodised surface, connecting screws: V2A stainless steel, Infill panels Polycarbonate, 2 mm, Plastic parts PA 6 GF 15, polyamide with 15% glass fibres |
| Colour   | Standard white, translucent. On option 29 colours, 21 designs  |



Butterfly Folding wall RBF / RBF 200 **29** colours

Colours and designs on option



Butterfly Folding wall RBF / RBF 200 **21** designs



Customize your folding wall online:



Colours based on RAL D2. Printed colours may deviate for technical reasons.

# Butterfly Paravent Model RBP

Non-see-through 360° hinges

**10** YEARS warranty on hinge system



Available in 3 dimensions

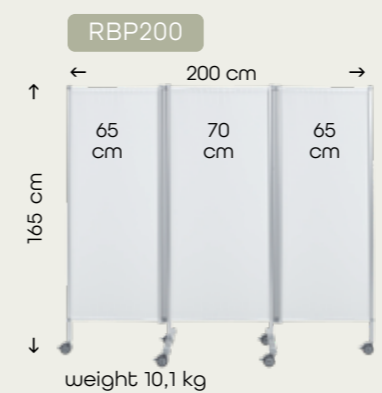
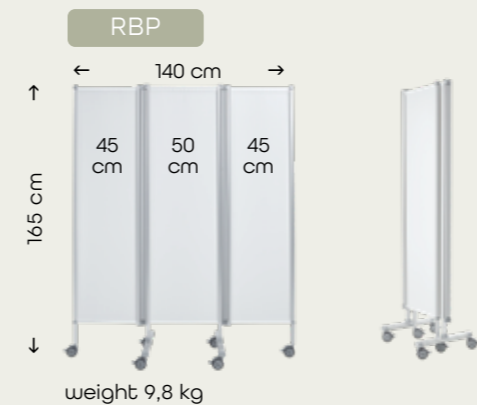

## ropimex® butterfly paravent RBP

3-leaf, with middle leaf centred on double T-leg and 360° rotatable leaves on either side, Fold-away

|          |   |
|----------|---|
| Material | Frame: Aluminium design profiles, natural-anodised, made of polyamide, light grey On option: Plastic castors, Ø 65 mm lockable  |
| Covering | Standard covering staph CHEK. staph CHEK Fabric is antibacterial, flame-resistant, self-extinguishing, antistatic and durable. It does not have to be washed. Stains are easily wiped off with wipes. Available with ropitex-covering for an additional charge. |
| Colours  | white, light blue, yellow, beige, mint  |

## Recommended curtains

see from page 22

VHC staph CHEK

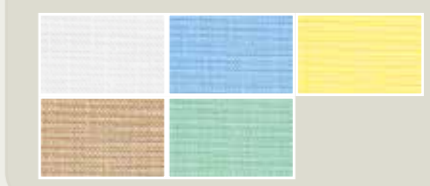

# Lightweight paravent Model RLP

Non-see-through 360° hinges

10 YEARS warranty on hinge system



Paravent leaves must always be positioned at an angle to each other, unless the ropimex® base (model RLP/C) is used See page 45.

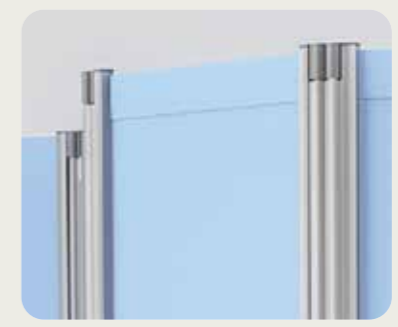

ropimex®-Lightweight paravents are convincingly easy to handle. The 360° non-see-through hinges each leaf enable each leaf to be moved into the required position. Covering without drapery.



### ropimex® lightweight paravent RLP

|          |  |
|----------|--|
| Material | Frame: Aluminium design profiles, natural-anodised, Foot and cover caps made of polyamide, light grey. On option: Plastic castors, black   |
| Covering | <p>Standard covering staph CHEK. staph CHEK Fabric is antibacterial, flame-resistant, self-extinguishing, antistatic and durable. It does not have to be washed. Stains are easily wiped off with wipes. Available with ropitex-covering for an additional charge.</p> <p>Recommended Curtains see page 23</p>  |
| Colours  | white, light blue, yellow, beige, mint   |





Base to stabilise the lightweight paravent Model **RLP/C**



Base RLP/C



holding up to 4 paravents

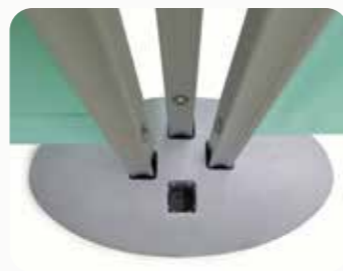

3 paravents in the base



4 paravents in the base



Paravents in a row as a routing system



ropimex® base for lightweight paravents

|                   |   |                                   |                                   |
|-------------------|---|-----------------------------------|-----------------------------------|
| Model RLP/C       | Base to stabilise the paravent when opened out straight (use of the open width) and/or for holding several paravents (max. 4 per base), as a partition or for setting up a routing system |                                   |                                   |
| Material          | Glass-fibre reinforced polyamide (GRP)  |                                   |                                   |
| Dimensions/Weight | 8 x 15 x 30 cm (H x W x D), weight 1,3 kg   |                                   |                                   |
| Variations        | <p>1 Paravent in a line</p>   | <p>1 Paravent at right-angles</p> | <p>up to 4 paravents possible</p> |

Lightweight paravent for wall-mounting Model **RLP/W**



ropimex® Lightweight paravent RLP with wall connector

| Model  | Leaf | Weight | Width  | Height |
|--------|------|--------|--------|--------|
| RLP/W2 | 2    | 3,8 kg | 100 cm | 165 cm |
| RLP/W3 | 3    | 5,7 kg | 150 cm |        |
| RLP/W4 | 4    | 7,6 kg | 200 cm |        |
| RLP/W5 | 5    | 9,5 kg | 250 cm |        |

Accessories

|         |  |  |
|---------|--|--|
| RLP-WA  | Spacer for wall fixing, standard spacing 100 mm, special length to customer-specified dimensions possible up to 400 mm |  |
| RLP-KLS | Clamp set for fixing to double-track standard rail   |  |
| RLP-ES  | Upright made of stainless steel for RLP/W, for free-standing installation in the room, height 1,650 mm                 |  |

# Shower splash guard Telescopic screen cubicles

Model **RDSE/RDLE/RDTE**

Model **RKLE**

Wall mounts  
WH/F, WH 95 see p.15



Curtain rings  
included in the scope of  
delivery. Colour grey.



## Telescopic screen cubicles

With this space-saving model it takes just a few seconds to create a screen for washing, changing either as a corner solution or as a U-shaped solution.

| Corner solution   |   | recommended wall mount |
|-------------------|---|------------------------|
|                   |   |                        |
| RKLE 1212         | Telescopic screen cubicle, max. 120/115 cm, min. 75/70 cm                             | WH 95 or WH/F          |
| RKLE 1515         | Telescopic screen cubicle, max. 150/145 cm, min. 90/85 cm                             |                        |
| U-shaped solution |   | recommended wall mount |
|                   |   |                        |
| RKAE 1.2          | Telescopic screen in combination with RKLE 1212 as a U-shaped solution 120x115x120 cm | 2 x WH/F               |
| or RKAE 1.5       | Telescopic screen in combination with RKLE 1515 as a U-shaped solution 150x145x150 cm |                        |



## Shower splash guard

| Model | Telescopic extension  | recommended wall mounts |
|-------|---|-------------------------|
| RDSE  | Splash guard arm swing-out and Fold-down, dimension 100 cm  |                         |
| RDTE  | Splash guard arm swing-out, dimension 95 cm   |                         |
| RDLE  | Splash guard arm, L-shaped, can be used on the right and left-hand side, side leg 25 cm, swing-out and fold-down, dimension 95 cm | WH 95 or WH/F           |



Recommended curtains for wet room areas: CQ, VH/C see p. 23 -24

CQ Cleanique VHC staph CHEK



Recommended curtains for changing rooms: RTX see p. 22

RTX ropitex



# ropimex® convincing product quality for maximum customer satisfaction

ropimex® business divisions at the Neunkirchen site



## ropimex® Screen Systems

privacy protection systems  
and flexible partitions for  
healthcare facilities



## ropimex® Sound Protection

Privacy and sound insulation  
systems for the office area



## ropimex® Chemicals

Disinfectants, refinements,  
Mosquito and tick protection  
Ecological cleaning agents



# Satisfied customers around the globe



Since 1976, ropimex® has been busy finding solutions to protect the privacy of the sick and those in need of care.

The telescopic screens of the early years are still in use today. From them a system developed whose diversity, use and combination options provide a suitable solution for each and every customer.

All these properties, top advice from authorised stockists and the fastest possible delivery have secured ropimex® satisfied users in over 60 countries, all over the world.



# ropimex®

## Our commitment

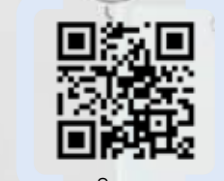

### Ecological / sustainable

- ropimex® products are 98 % sourced in Germany and 100 % manufactured at the plant in Neunkirchen/Saar.
- consistent recycling of our waste such as aluminium, fabric scraps, cardboard and plastic
- we are greatly reducing our paper consumption. Our goal: paperless office
- gradual conversion of electricity-intensive consumers
- our products are phthalate-free



Tree sponsor - ropimex® supports reforestation project from PLANT-MY-TREE®



### Social behaviour

- Well-being is a priority. We are happy to invest in the environment of the company
    - whether it's spacious, open-plan offices with modern equipment,
    - friendly communal areas,
    - flexible working hours or
    - homeoffice
- thanks to these practical measures, the sickness rate is low, the fluctuation rate is virtually zero.



### Commitment

We also want those to benefit who are unable to participate in the performance process, or only to a limited extent. For years, we have been involved as a partner in the Lebenshilfe organisation and other measures, particularly those that support young people.

- Partner-Company 2024 - Ropimex R. OPEL GmbH is a Partner-Company of DOCTORS WITHOUT BORDERS / MEDECINS SANS FRONTIERES, we support their work with our donation.

DOCTORS WITHOUT BORDERS provides emergency medical relief in areas fraught by crisis, war, or natural catastrophes. The international organisation helps people quickly, effectively and unbureaucratically, irrespective of their race, religion or political orientation. For further information: [www.msf.org](http://www.msf.org)



### Medical device

ropimex® products meet the requirements of the regulatory specifications for medical devices.

The systems are designed so that a patient zone / intimate zone can be created for virtually any existing condition - stationary or mobile.

ropimex® screen systems are customisable accessories for medical devices such as patient beds, treatment tables and treatment chairs in medical facilities.



### Certified according to: DIN EN ISO 9001:2015 and DIN EN ISO 14001:2015

The certification body of TÜV SÜD Management Service GmbH certifies that the company ROPIMEX R. OPEL GmbH, Bildstocker Str. 12-14, 66538 Neunkirchen, Germany has **introduced and applies a quality management system** for the scope of manufacture and sale of privacy and soundproofing elements. An audit was performed, Order No. 707145152. Proof has been furnished that the requirements according to DIN EN ISO 9001:2015 are fulfilled.

Furthermore, the company has **introduced and applied an environmental management system** for the production and sale of privacy screens and soundproofing elements as well as biocidal products, disinfectants and coating systems. An audit has provided proof that the requirements of DIN EN ISO 14001:2015 have been met.



### For your safety

ropimex® products meet the highest safety standards.

# Screen-Systems

Healthcare | 2025



Telescopic screens | Telescopic arms | Mobile screens | Vario rail system  
Curtains | Folding screens | Paravents | Shower splash guard



Scan

ROPIMEX R. OPEL GmbH  
Bildstocker Str. 12-14 · D-66538 Neunkirchen  
Tel. +49 6821 9 12 77-0  
info@ropimex.com · www.ropimex.com

**ropimex**<sup>®</sup>  
since 1976